

Varenummer: 2301077511
 Beskrivelse: E+G Håndhjul
 VR.180 FP

Mål

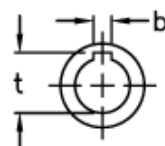
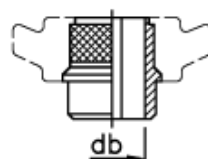
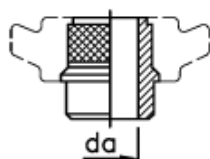
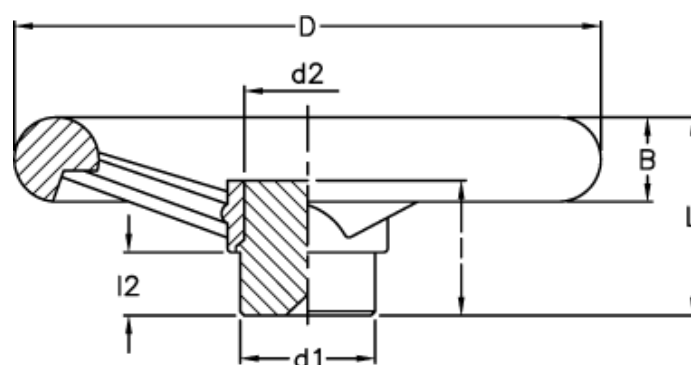

da max tilladelig
 boring uden not

db max tilladelig
 boring med not

B	= 24	l	= 43
b	= 6	L	= 56
C (N*m)	= 280	L (J)	= 15
D	= 180	l2	= 15
d1	= 40	t	= 24.8
d2	= 31		
da	= 26		
db	= 22		